

# Course #3 SET UP

Jumps must be 10' from long rail

Ground pole on the approach side of each jump

Measure from the approach side of the rail

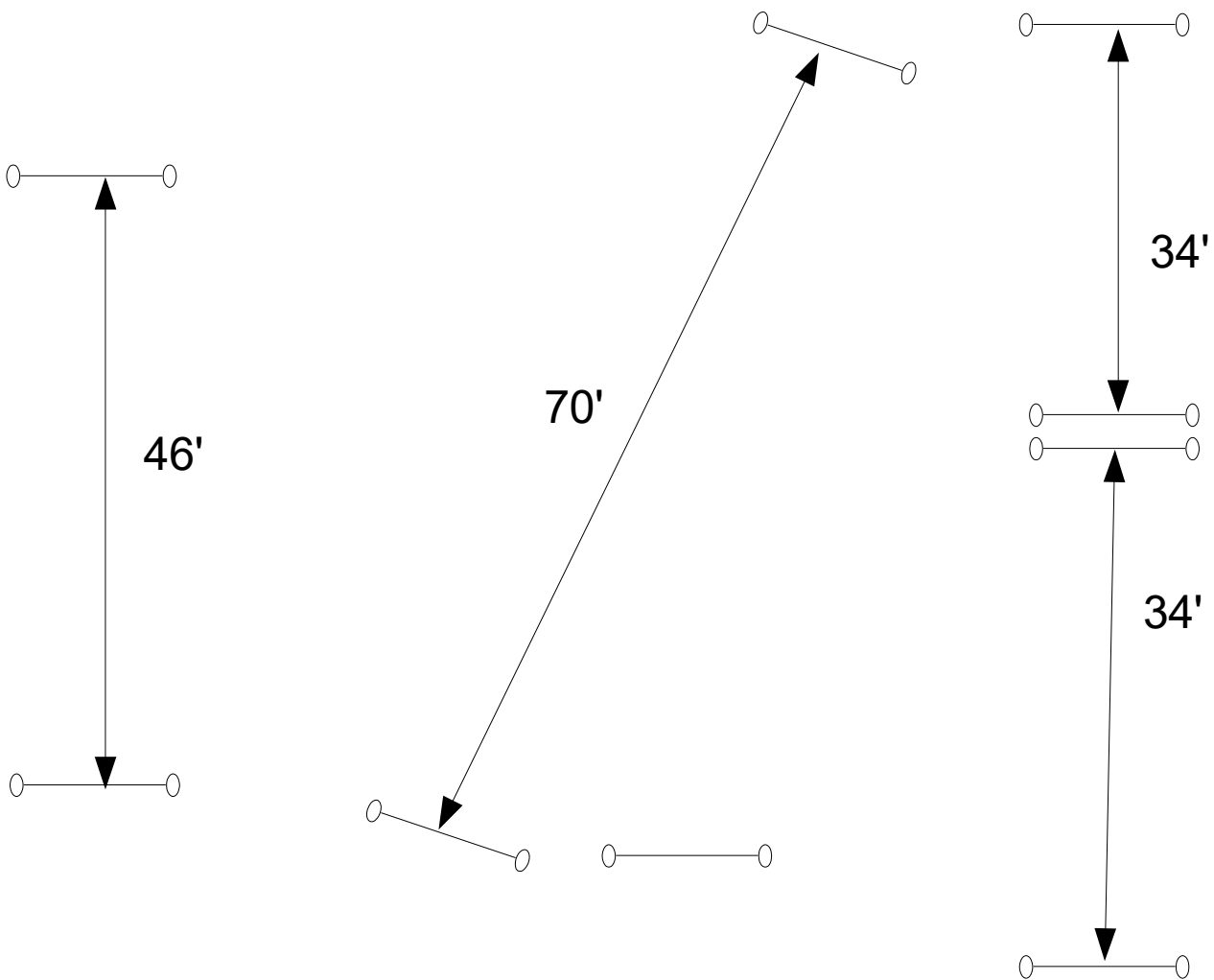

# Course #3 EQUITATION

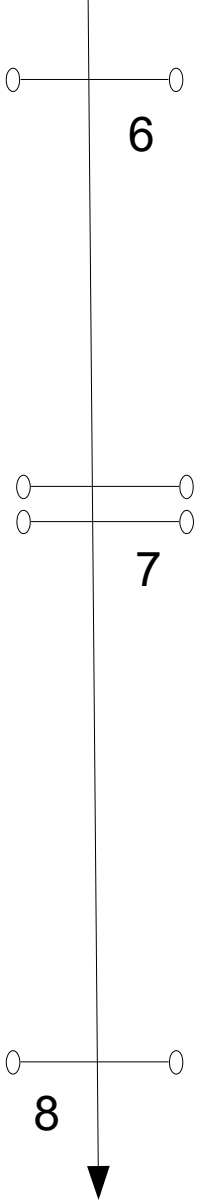
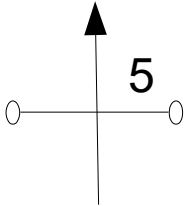
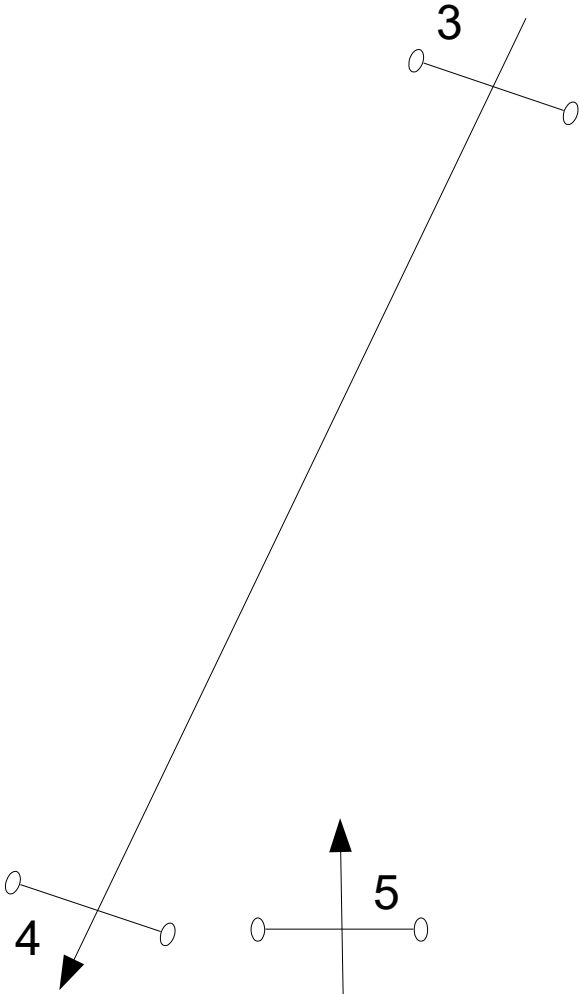
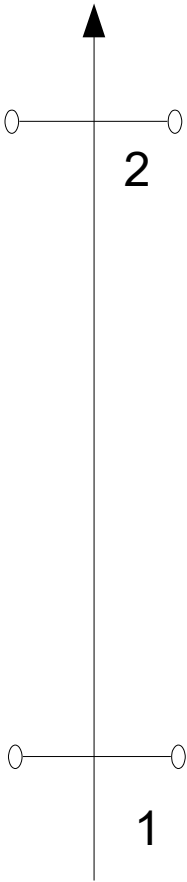

Course #3 HUNTER

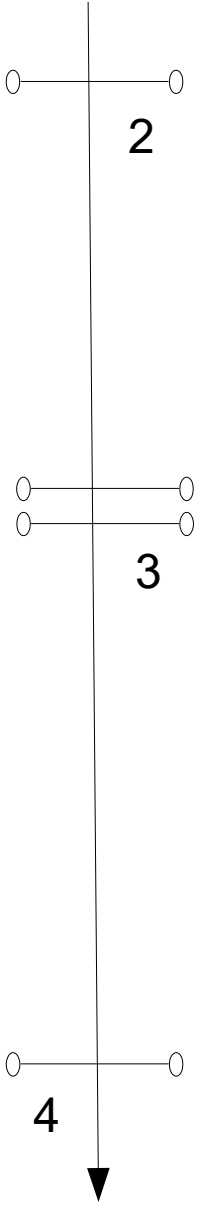
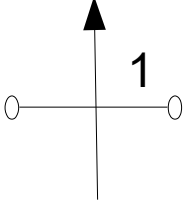
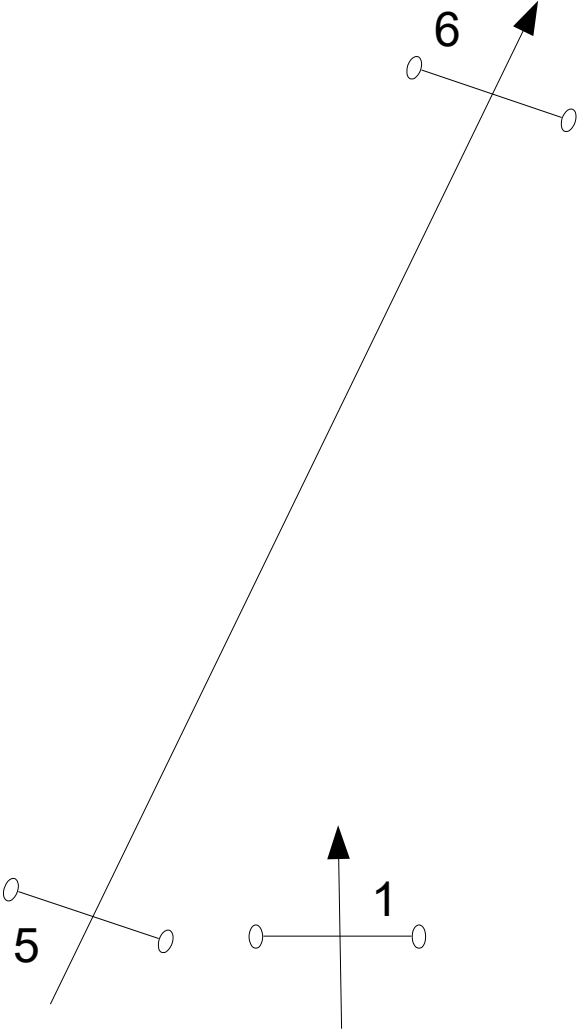
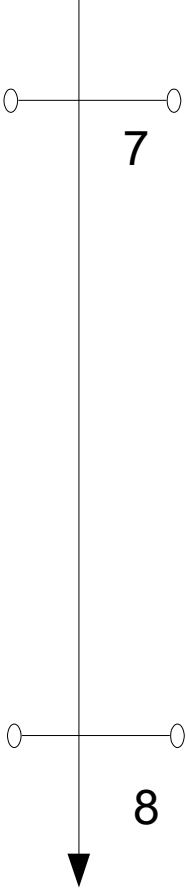

# Course #3 BRONZE

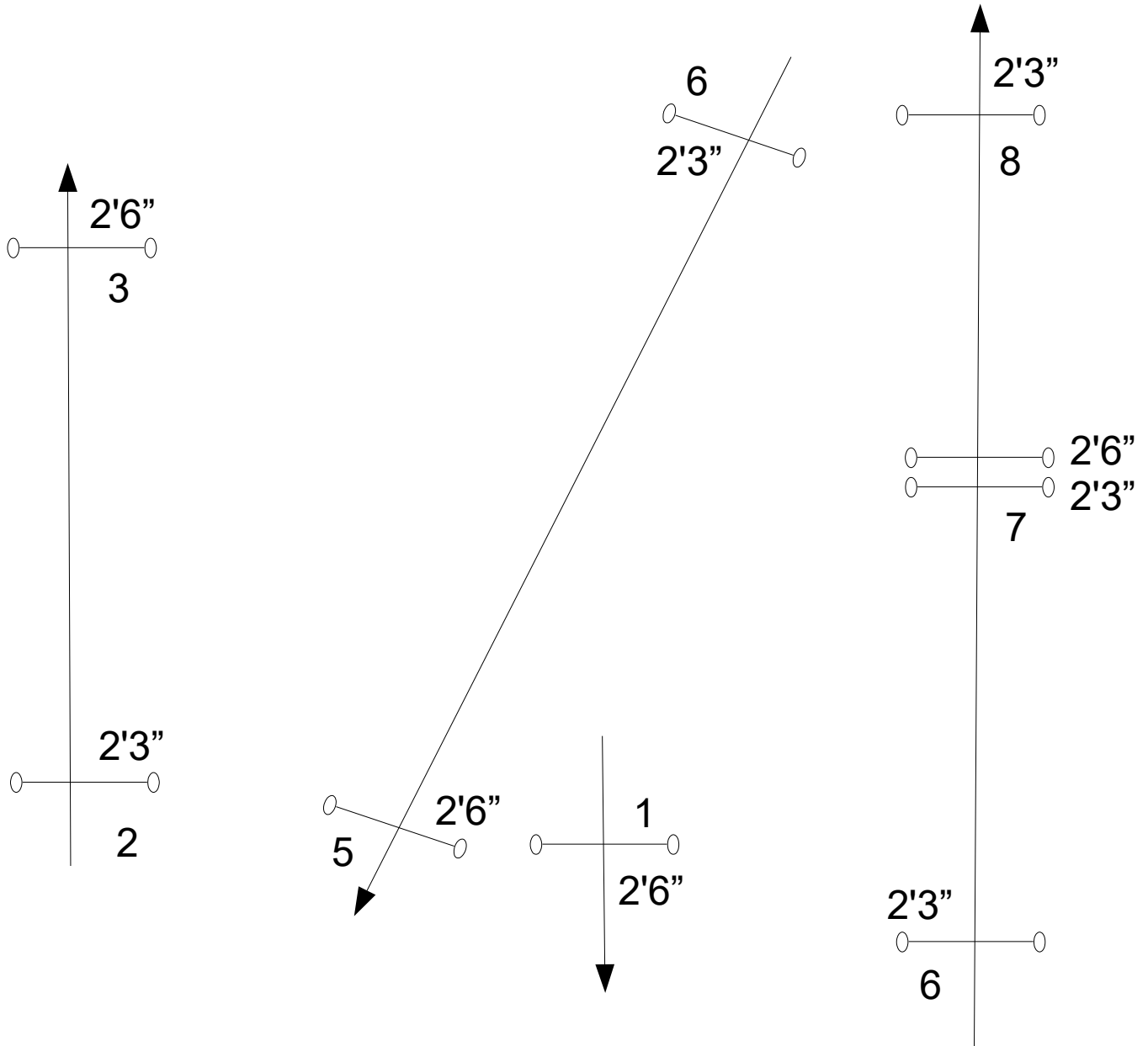

# Course #3 SILVER

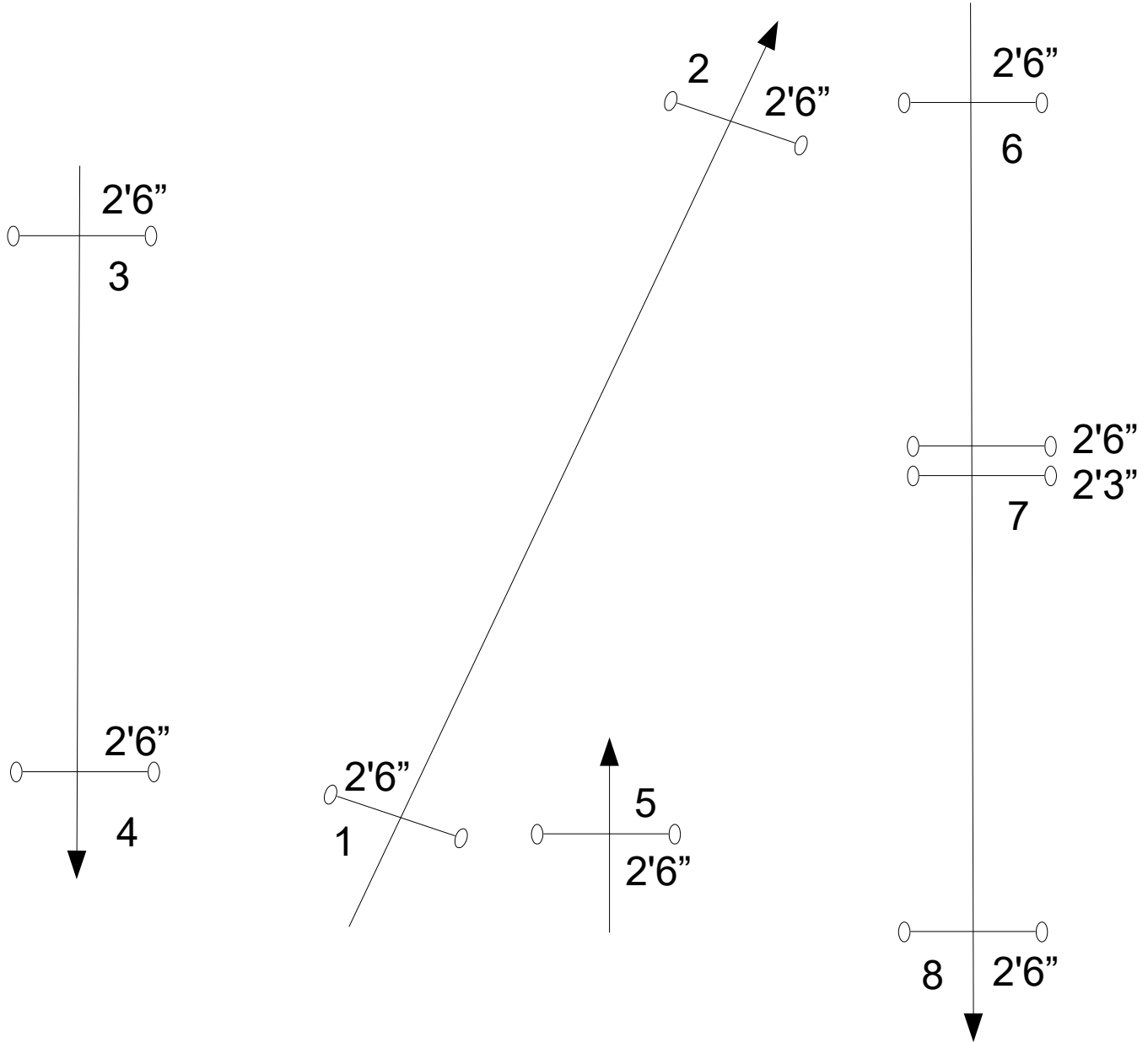

Course #3 GOLD

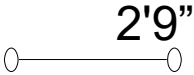
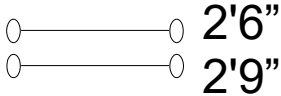
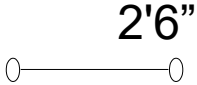
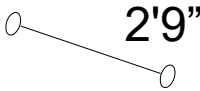
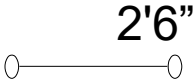

# Course #3 SUPREME

